

*madera de hogar!*

---

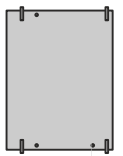

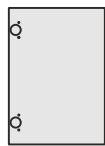

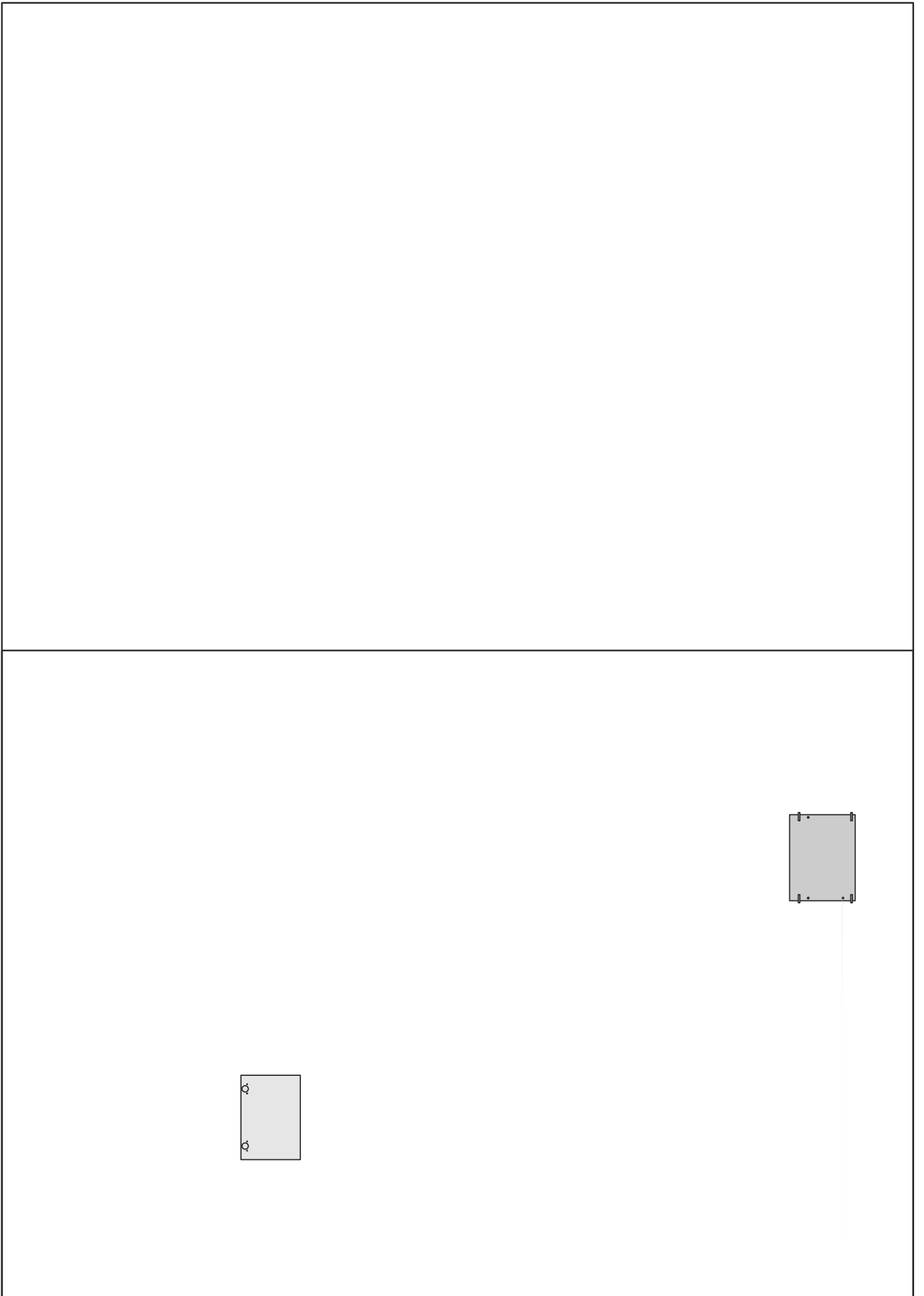
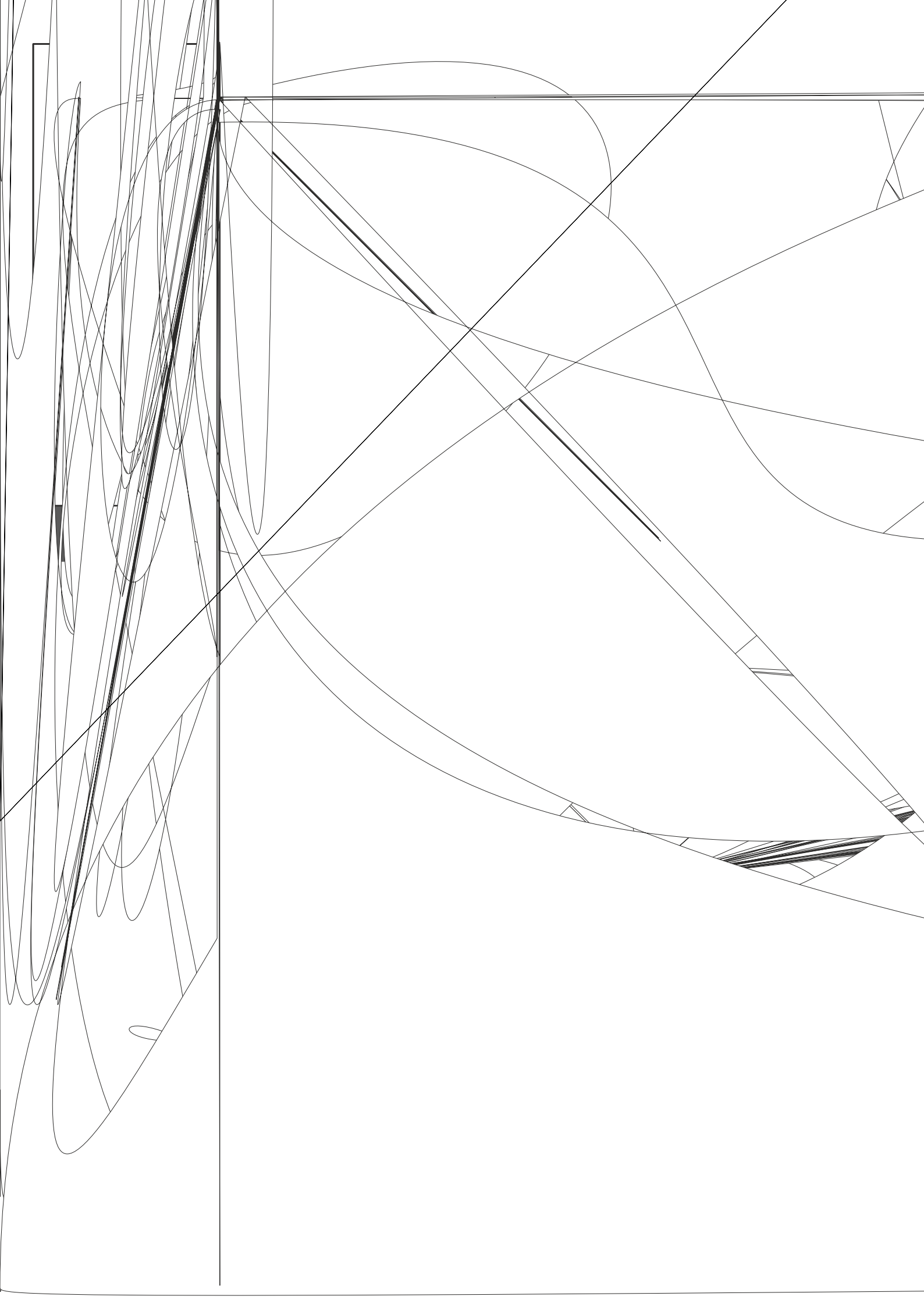

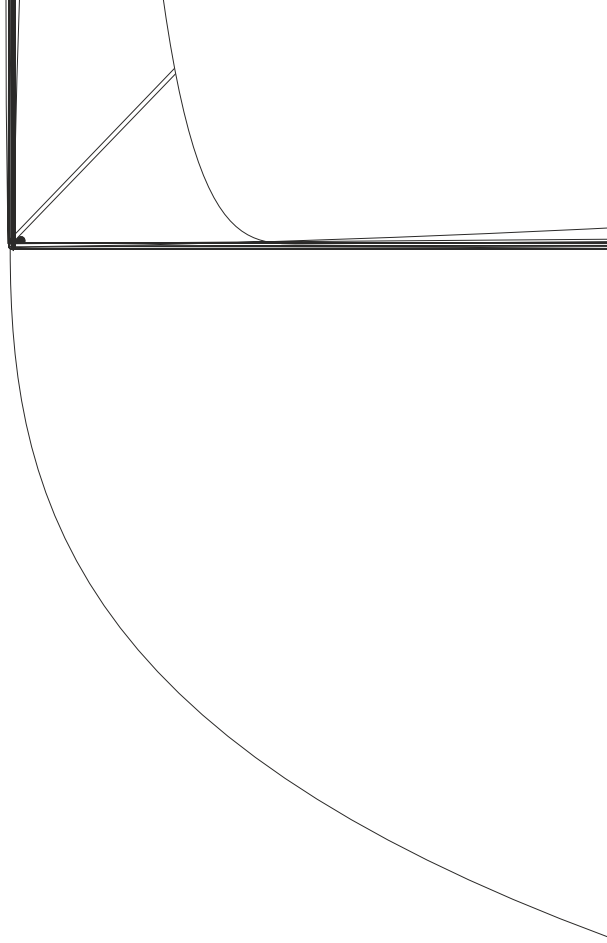

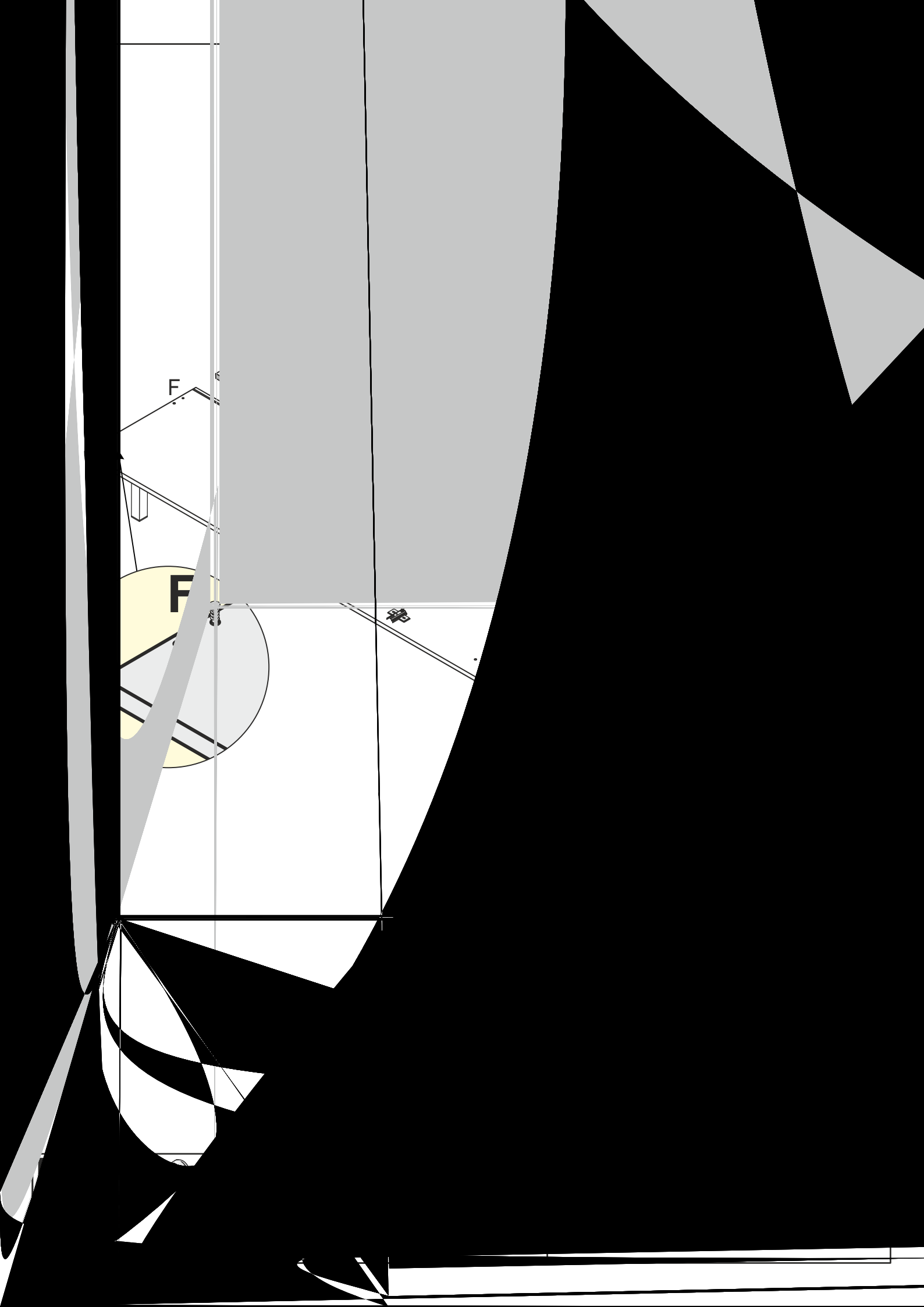

7

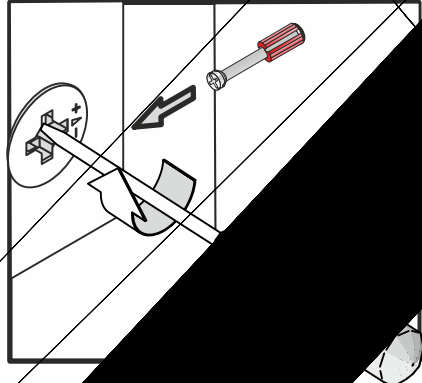
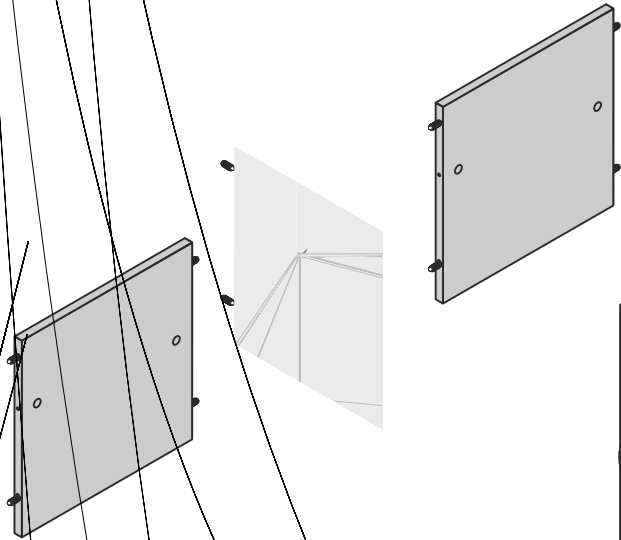

3

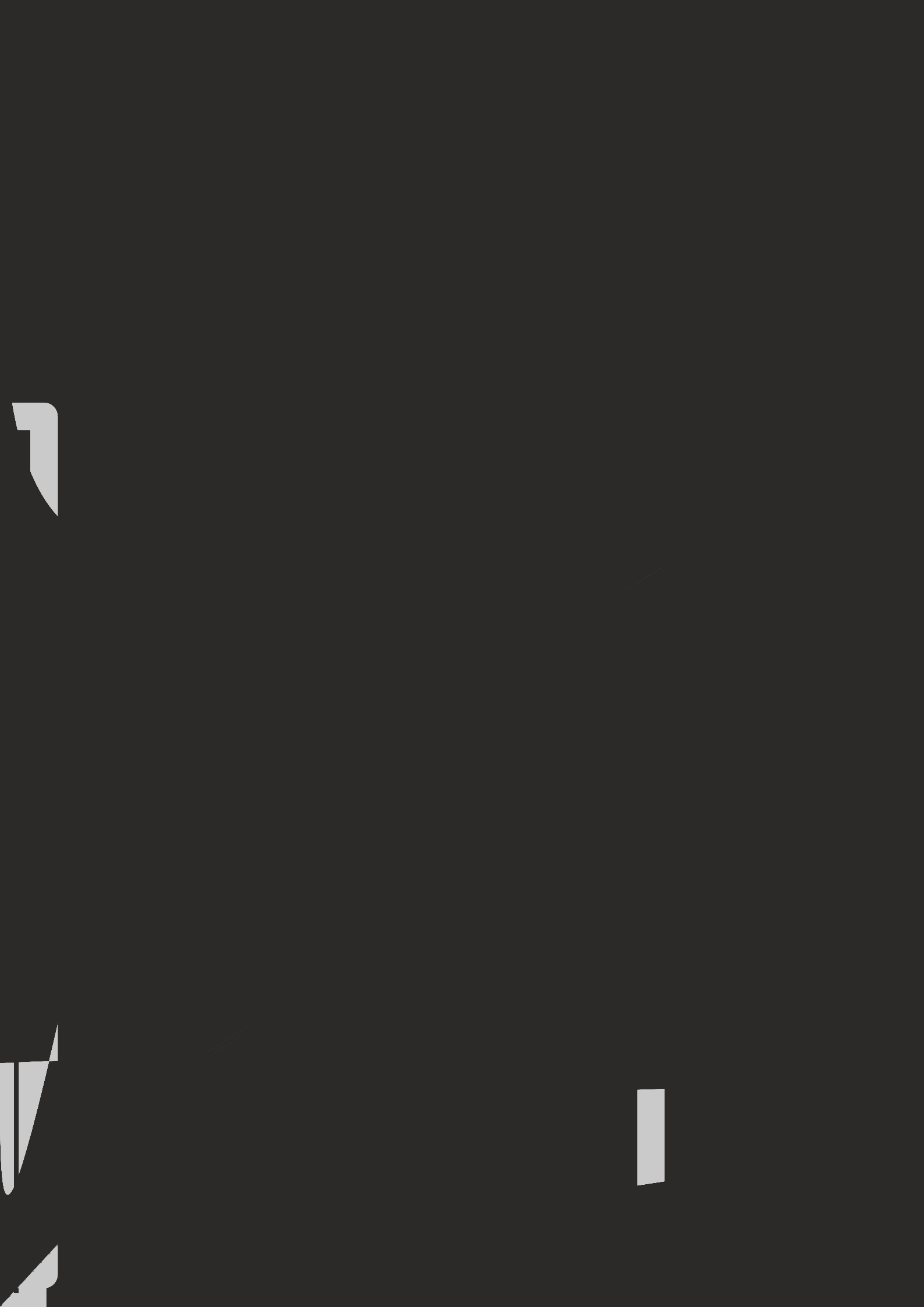



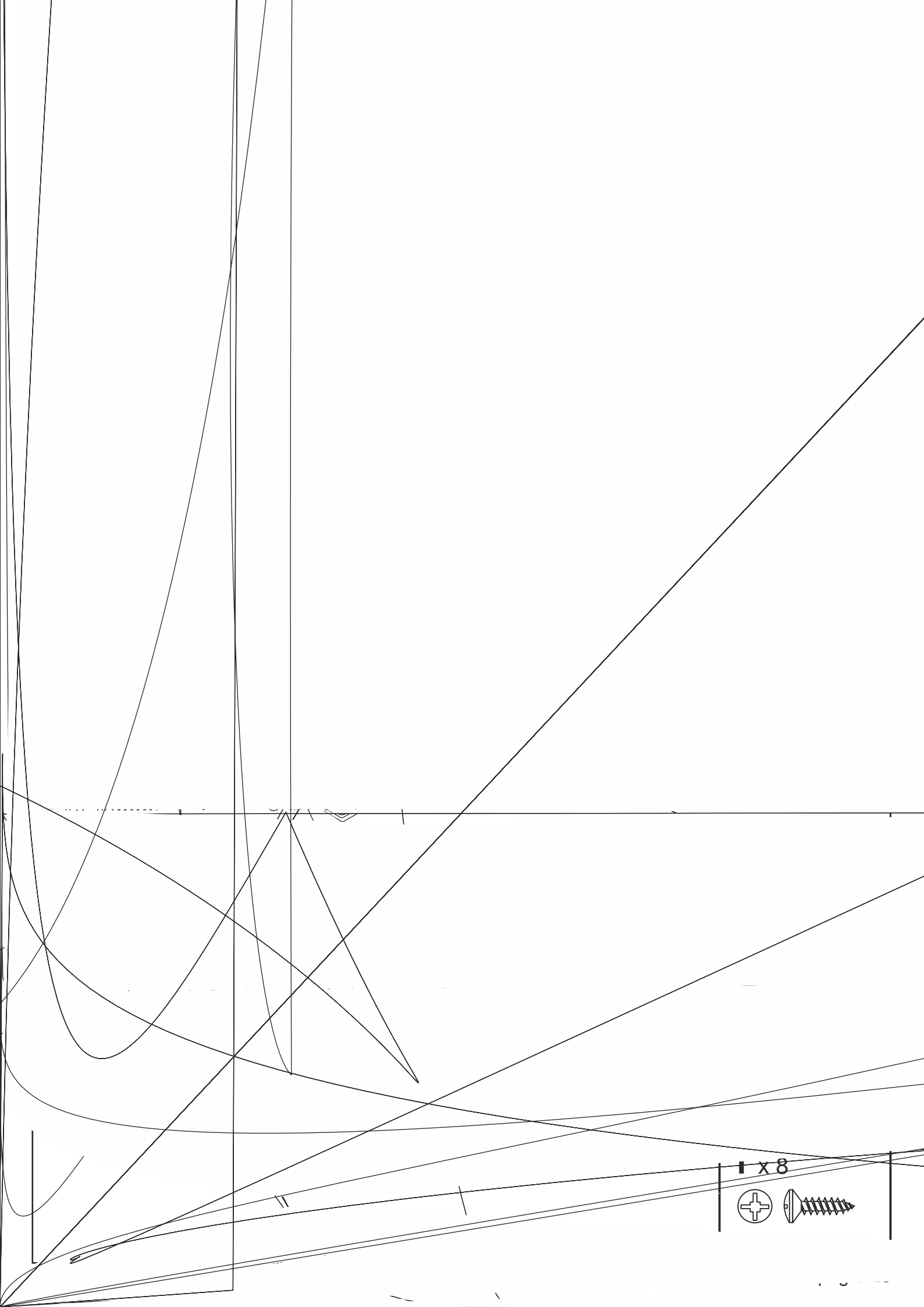

1 x 8

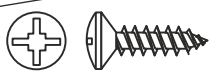

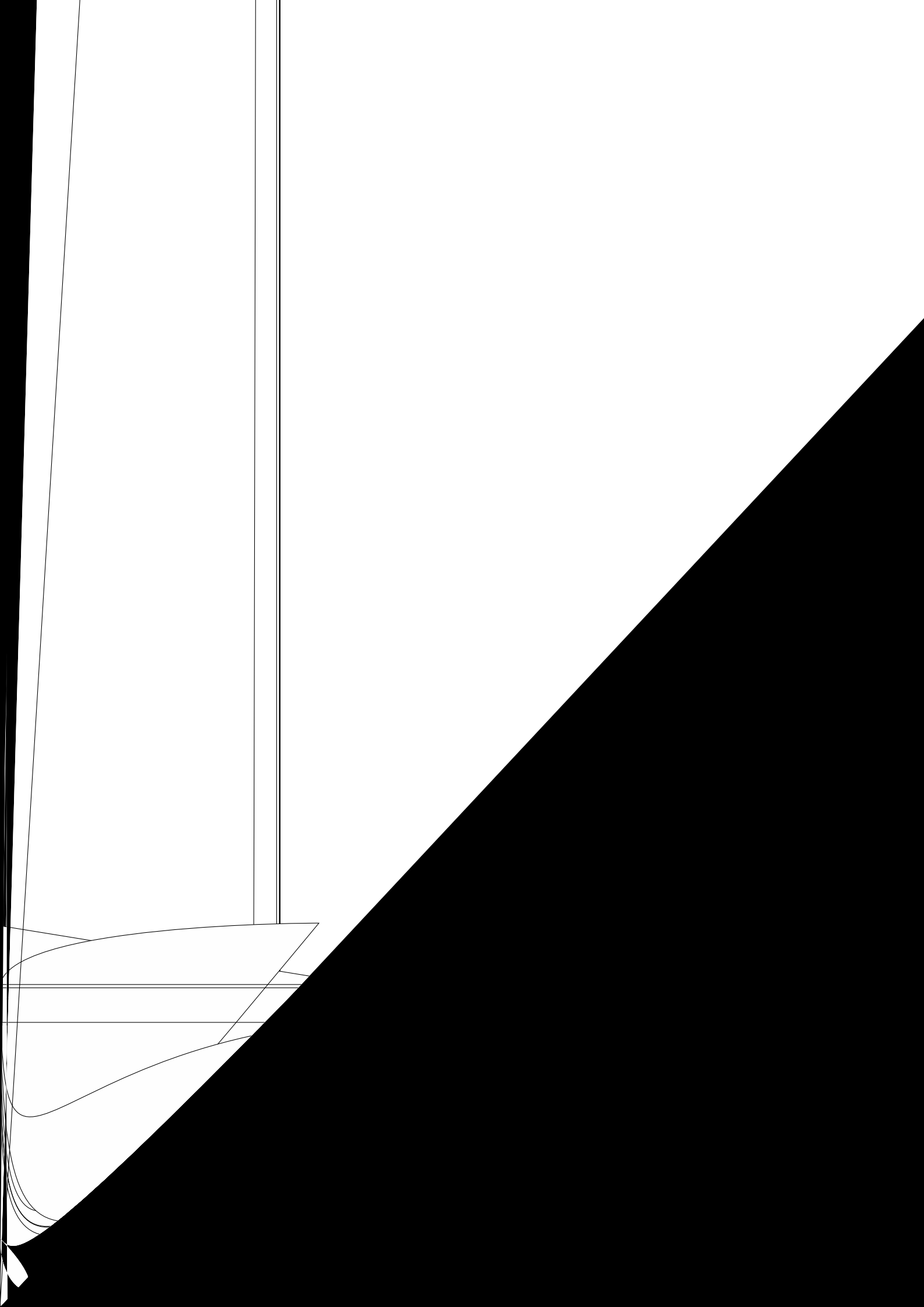

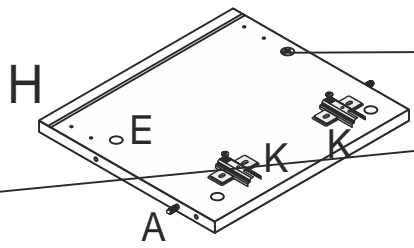

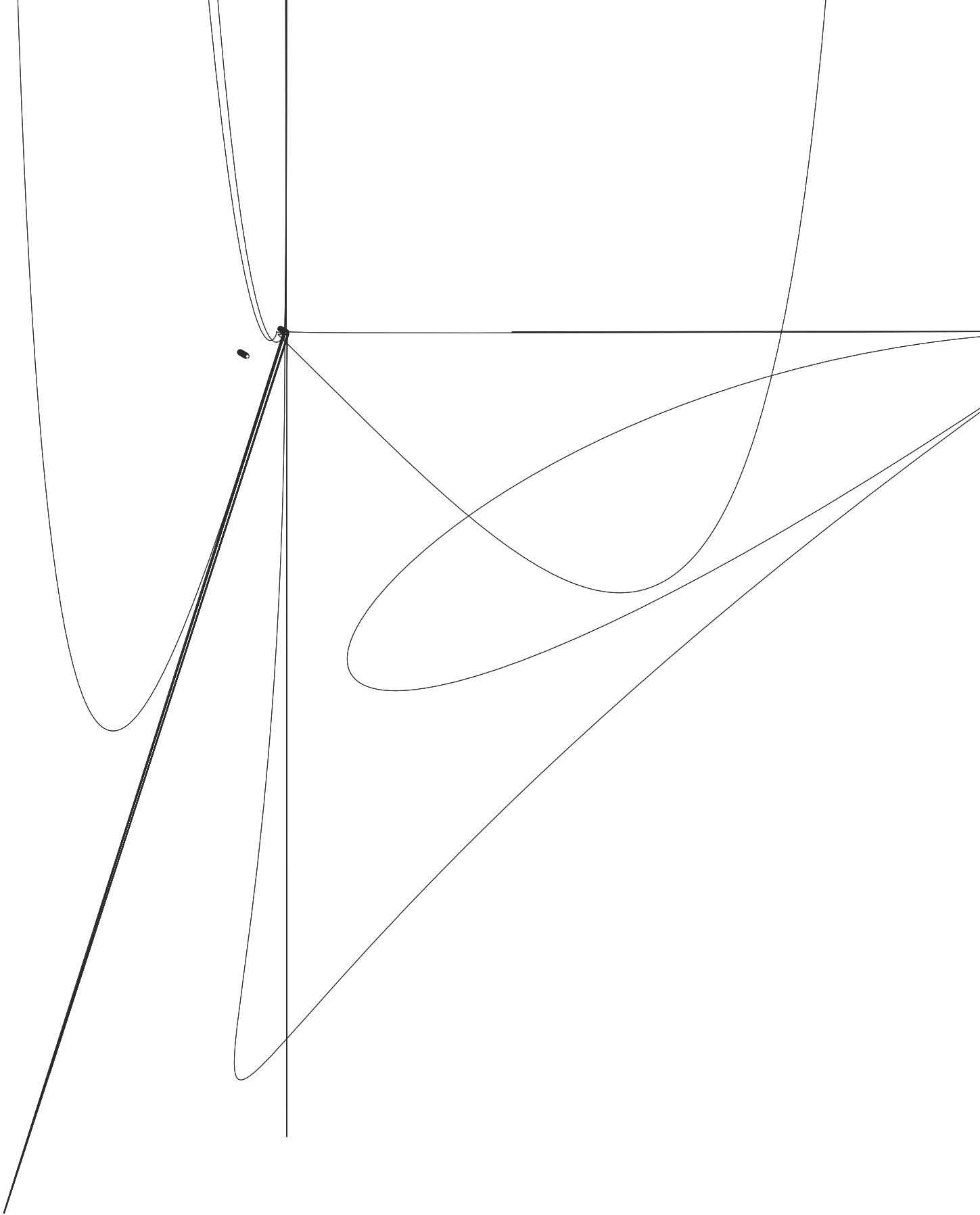



**23**

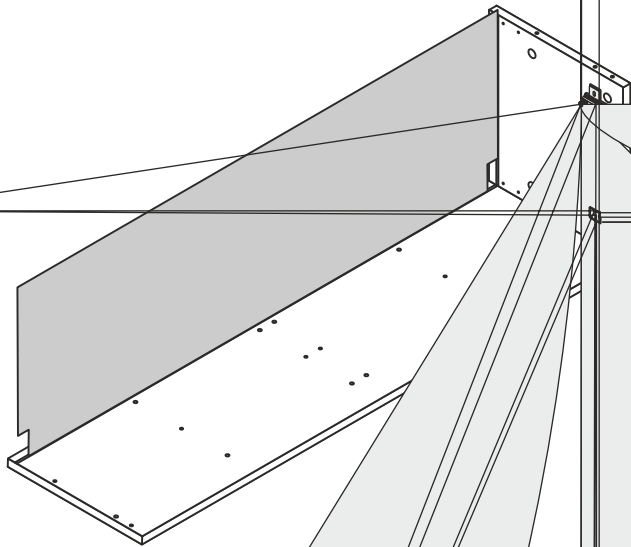

**24**

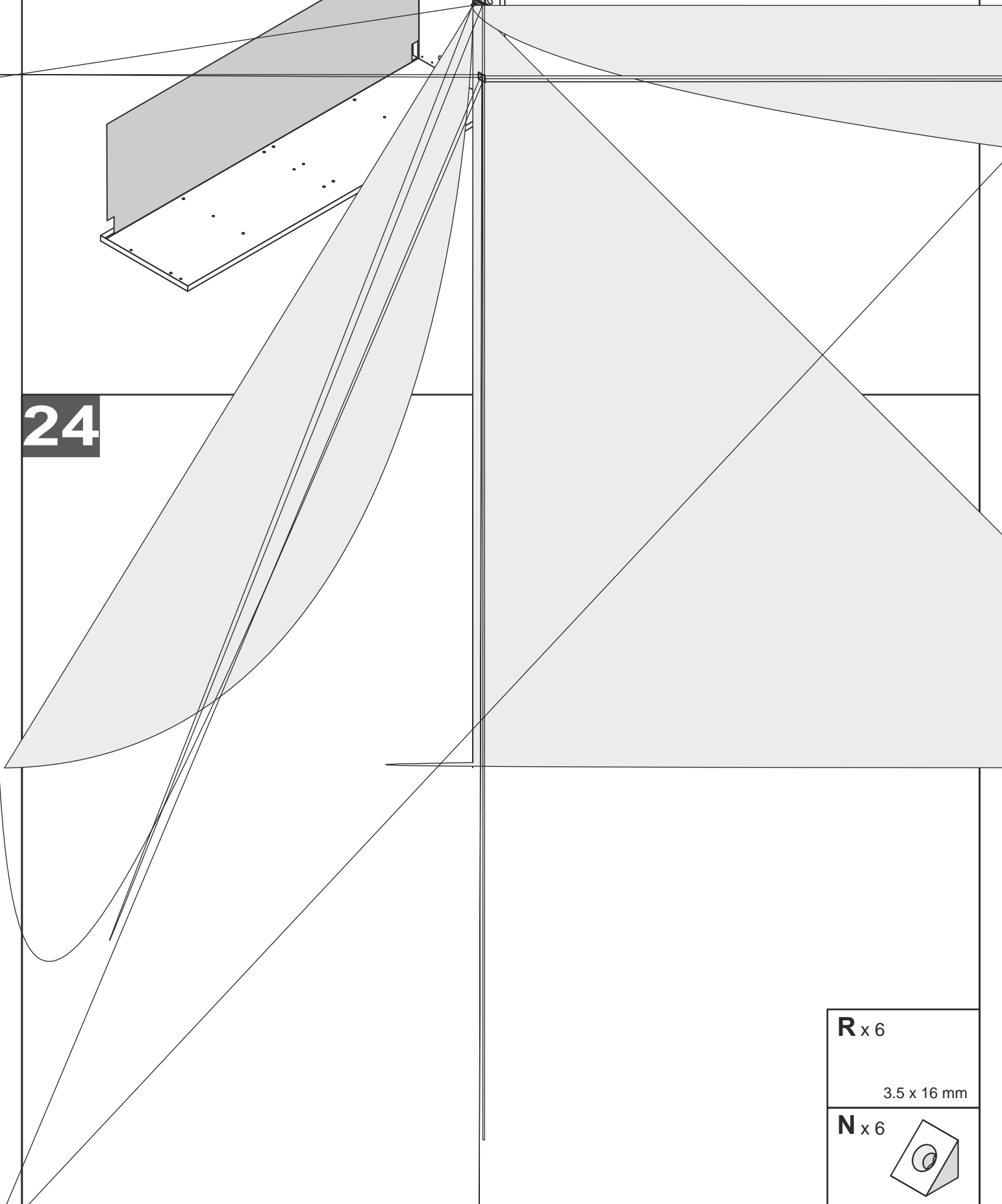

**R x 6**

3.5 x 16 mm

**N x 6**

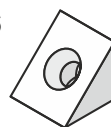

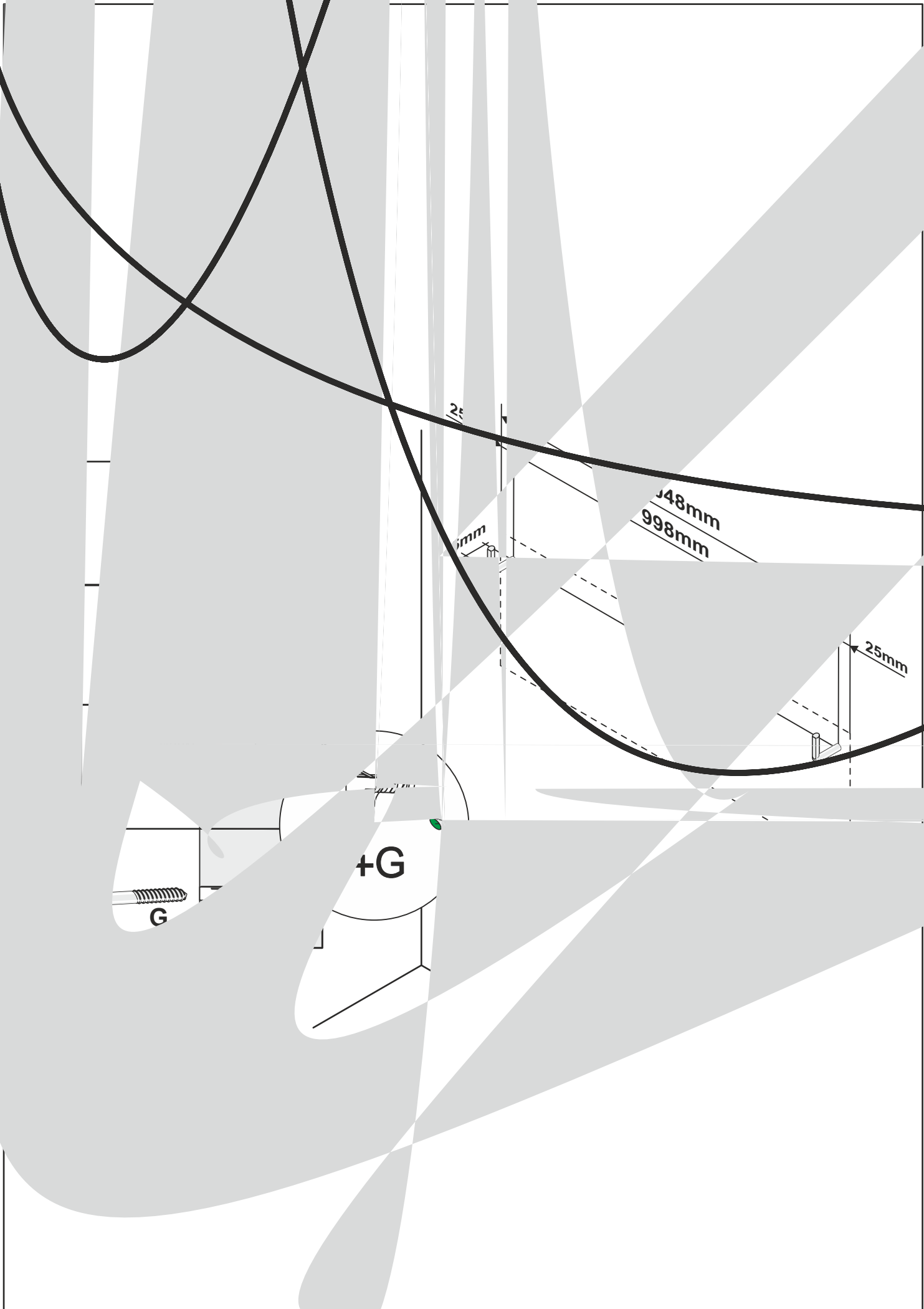

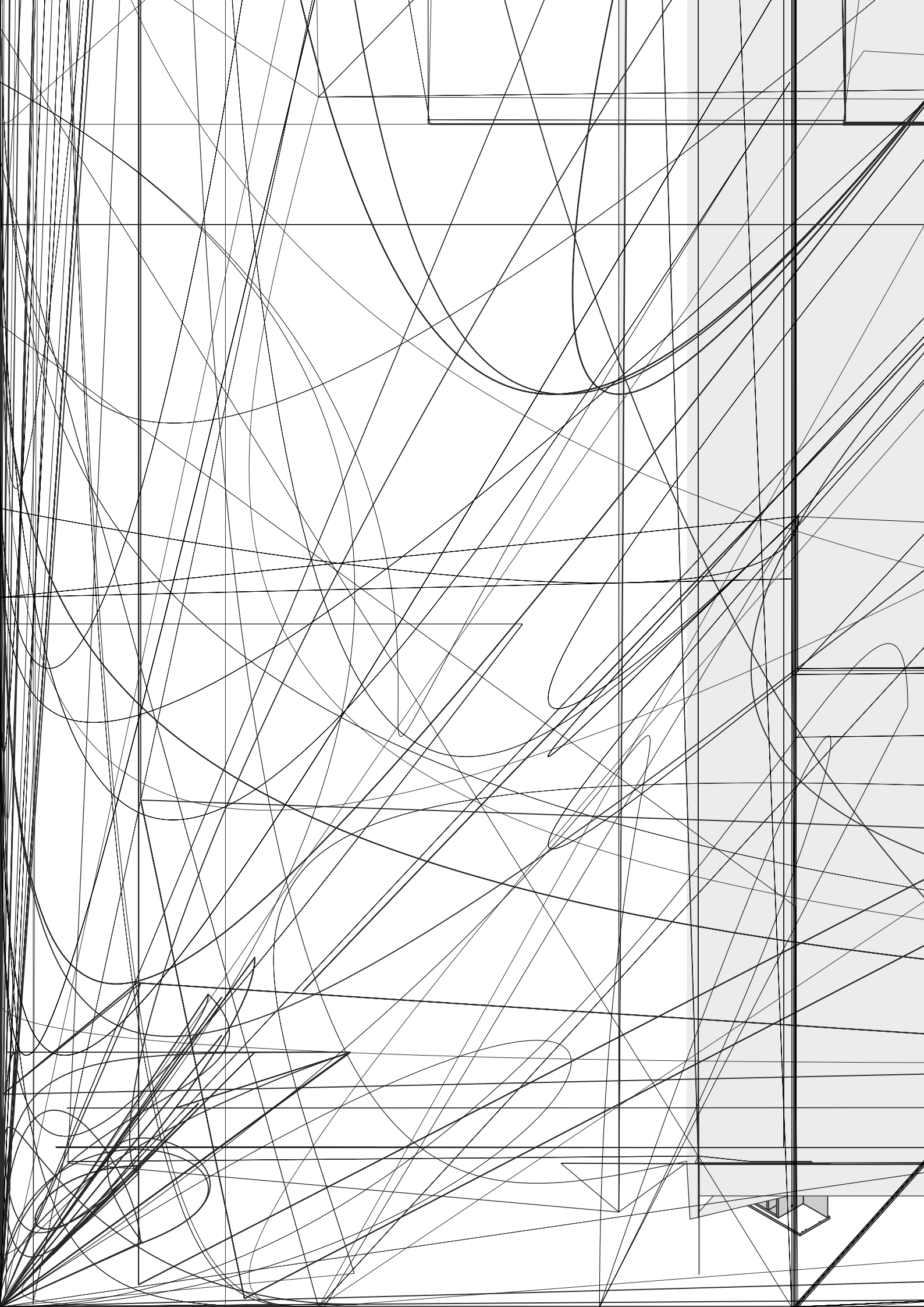



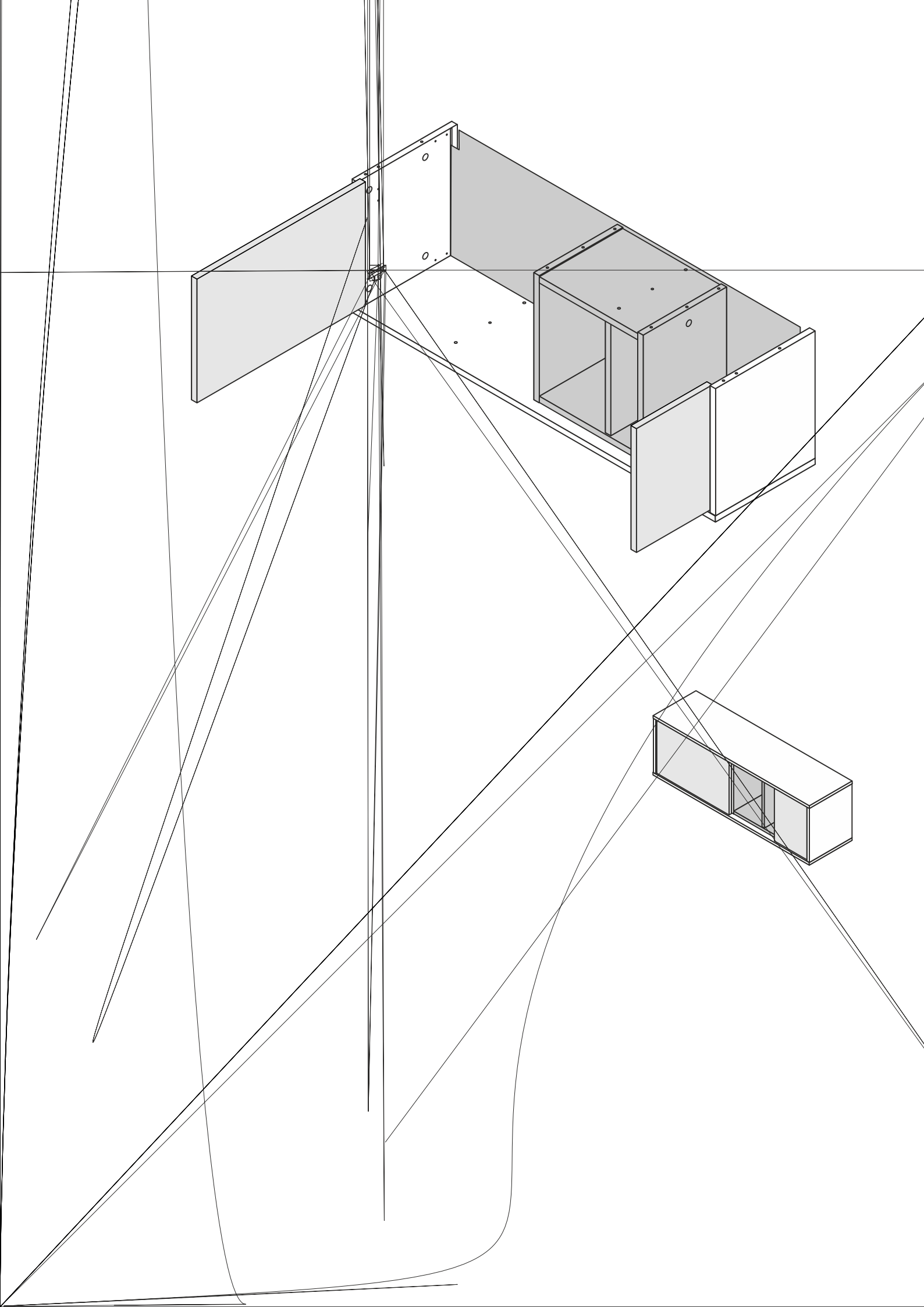



**NTIA**

fabricado  
2 año  
se enci  
**stven**  
garant  
mpresi  
factu  
st any  
ficult  
sed  
arar  
sat  
en  
pa  
nci  
**4**  
ndi  
ntie  
en  
J.E  
**? a**  
on  
l: p  
15f  
nã  
nan  
ag  
uzic  
colta  
tivo c  
on cc  
valid.  
Spani  
örung c  
ndwelc  
**postve**  
ie gilt nic  
n, um den

μ

a@for

